



African Junior Cup Casablanca 2019

(MAR Casablanca, 15 September 2019)

-60 kg

5 Judoka

	1	3	5	Wins	Scores
1 CHERKAOUI DEKKAKI, Mohammed MAR		+	-	1	(10)
3 MOUATAQID, Ayoub MAR	-		-	0	(0)
5 TAHRA, Mohammed Amine ALG	+	+		2	(20)

	2	4	Wins	Scores
2 GOTTHEINER, Arthur POR		+	1	(10)
4 ELALAMI ELIDRISSI, Anass MAR	-		0	(0)

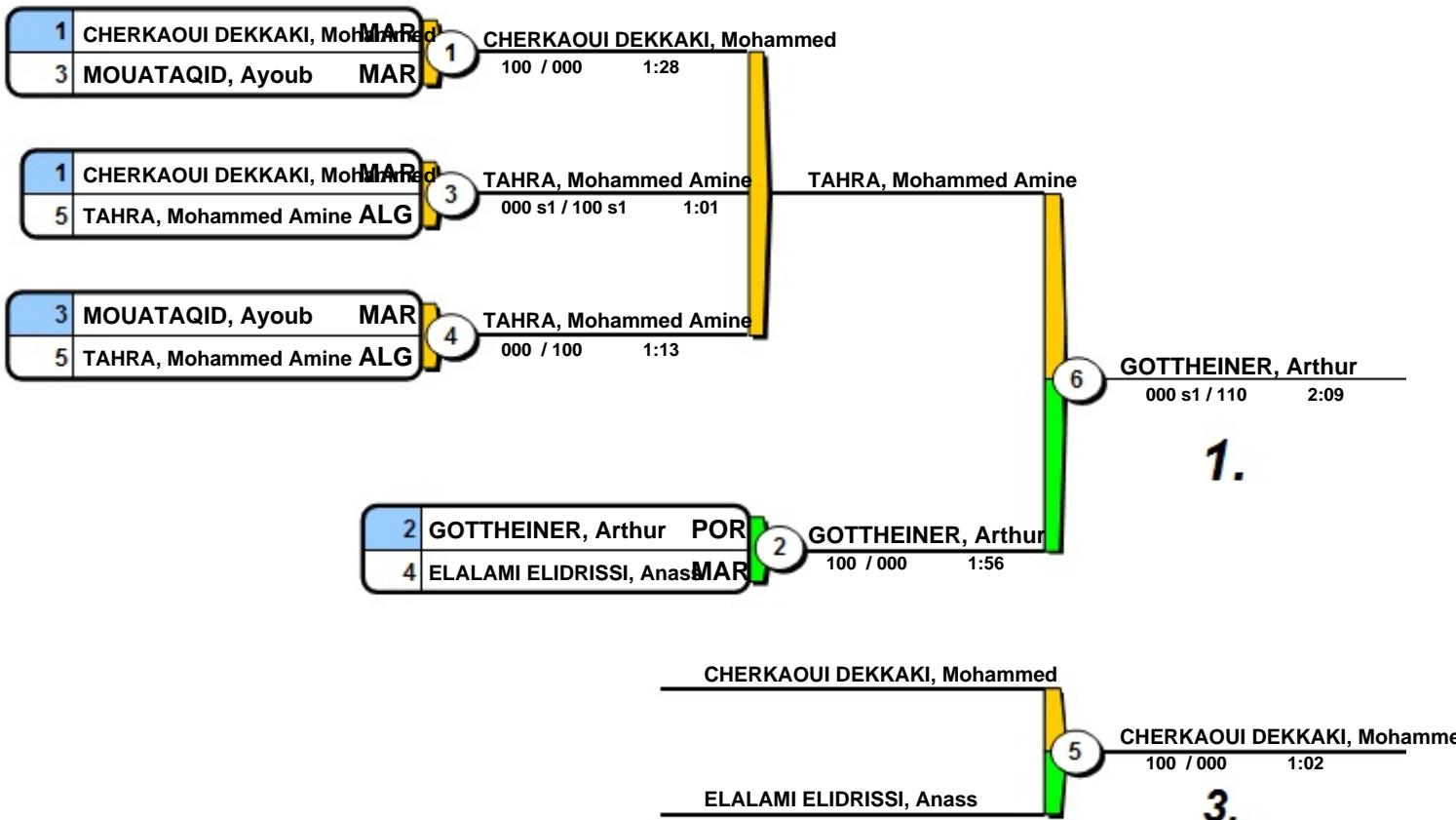

1. GOTTHEINER, Arthur **POR**
2. TAHRA, Mohammed Amine **ALG**
3. CHERKAOUI DEKKAKI, Mohammed **MAR**



African Junior Cup Casablanca 2019

(MAR Casablanca, 15 September 2019)

-66 kg

6 Judoka

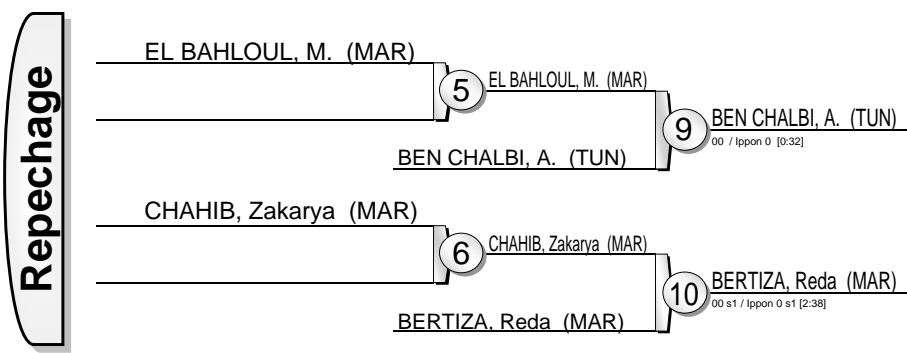
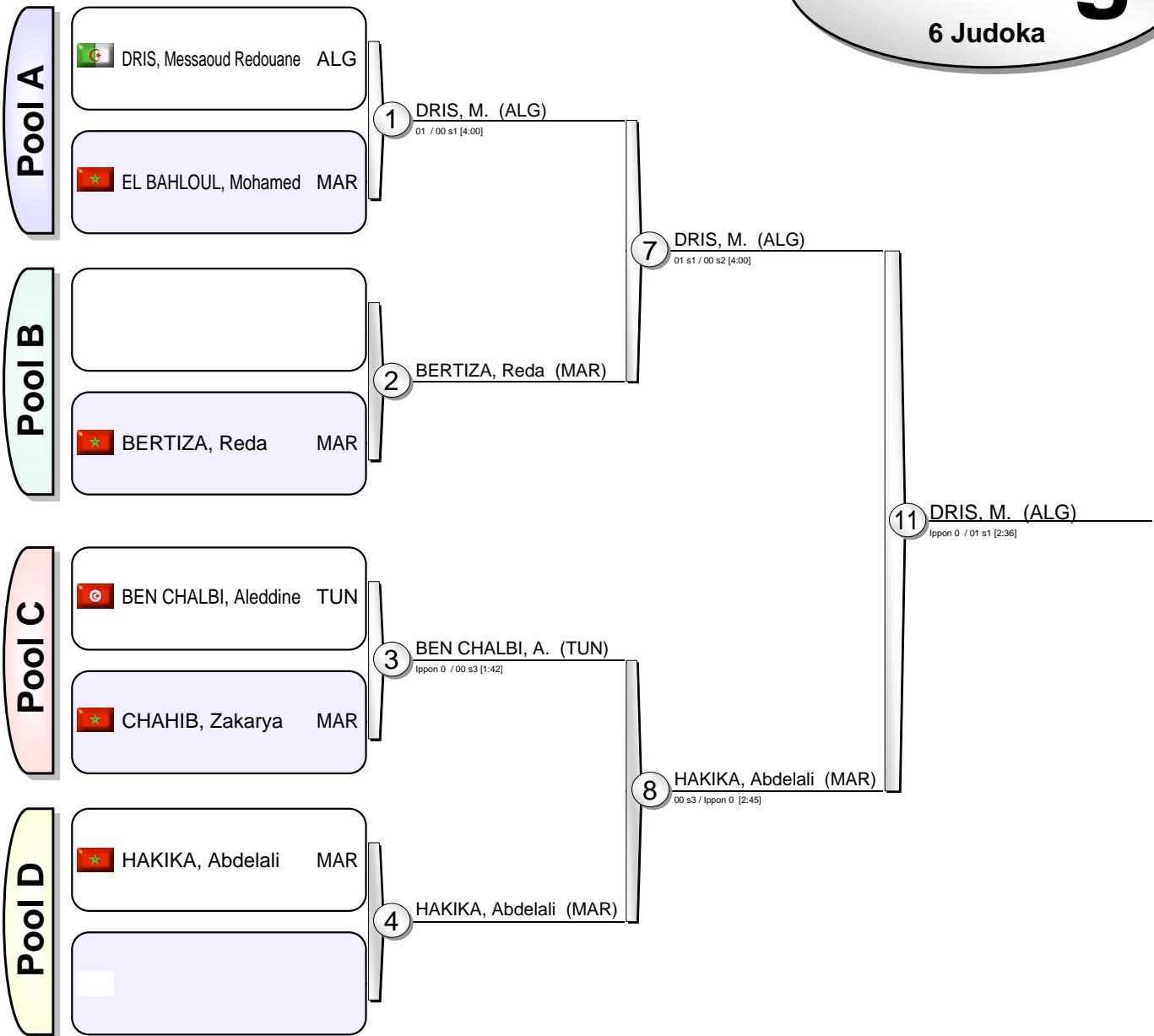

Results		
1.	DRIS, Messaoud Redouane	ALG
2.	HAKIKA, Abdelali	MAR
3.	BEN CHALBI, Aledidine	TUN
3.	BERTIZA, Reda	MAR
5.	EL BAHLOUL, Mohamed	MAR
5.	CHAHIB, Zakarya	MAR
7.		
7.		



African Junior Cup Casablanca 2019

(MAR Casablanca, 15 September 2019)

-73 kg

8 Judoka

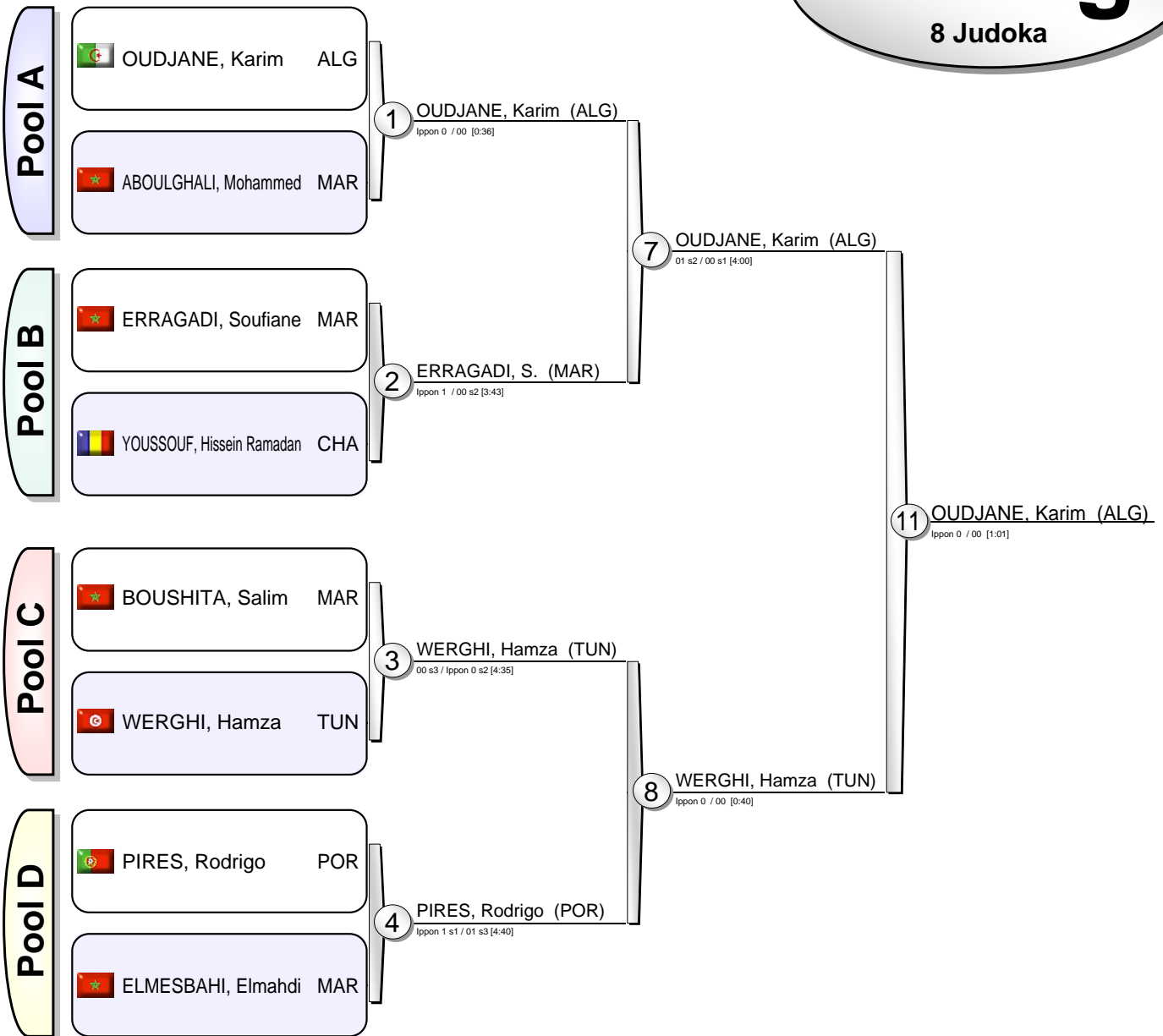

Results		
1.	OUDJANE, Karim	ALG
2.	WERGHI, Hamza	TUN
3.	PIRES, Rodrigo	POR
3.	BOUSHITA, Salim	MAR
5.	YOUSOUF, Hissein Ramadan	CHA
5.	ERRAGADI, Soufiane	MAR
7.	ABOULGHALI, Mohammed	MAR
7.	ELMESBAHI, Elmahdi	MAR



African Junior Cup Casablanca 2019

(MAR Casablanca, 15 September 2019)

-81 kg

6 Judoka

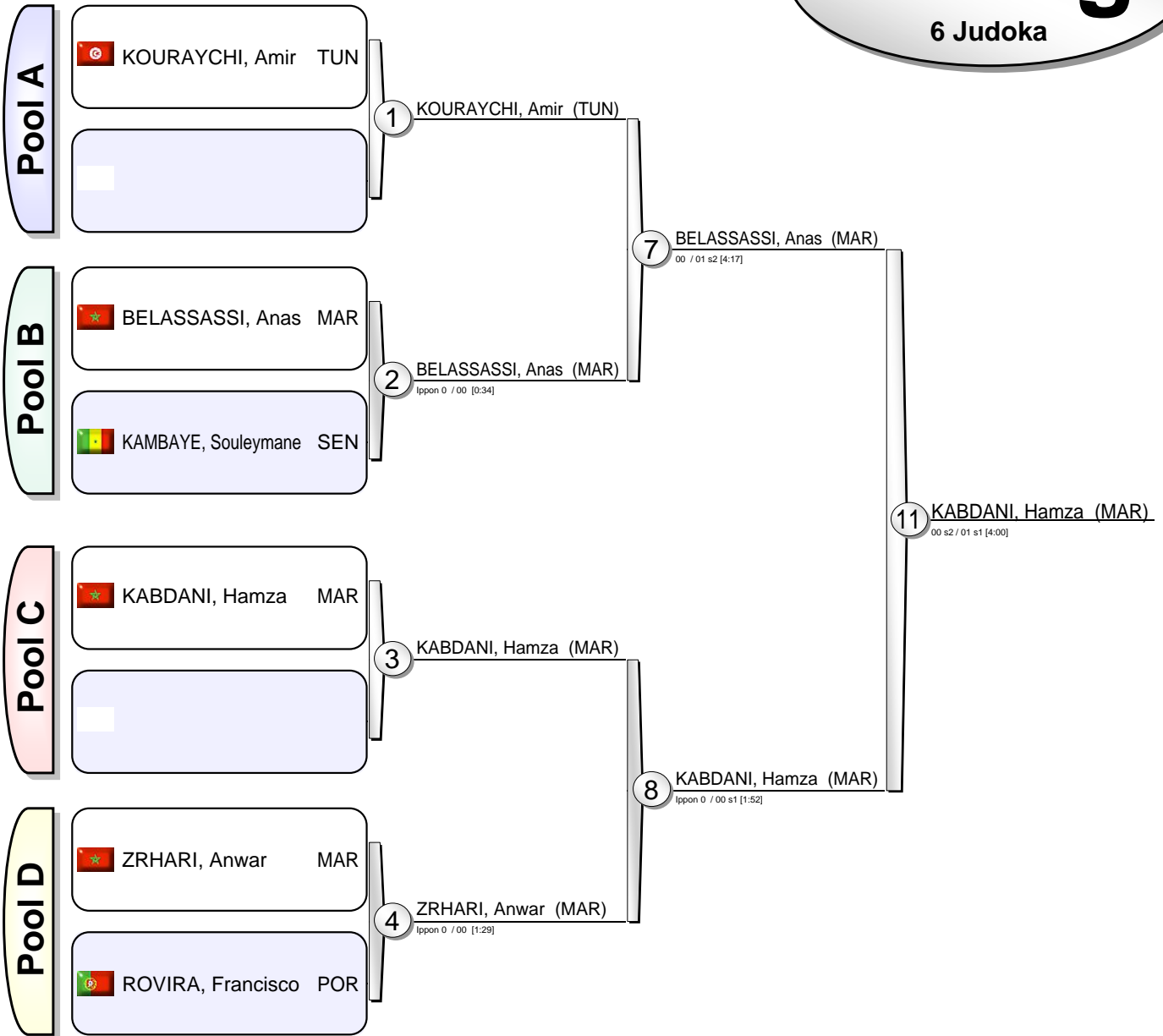

Results

1. KABDANI, Hamza MAR
2. BELASSASSI, Anas MAR
3. ZRHARI, Anwar MAR
3. KOURAYCHI, Amir TUN
5. KAMBAYE, Souleymane SEN
5. ROVIRA, Francisco POR
- 7.
- 7.



African Junior Cup Casablanca 2019

(MAR Casablanca, 15 September 2019)

-90 kg

4 Judoka

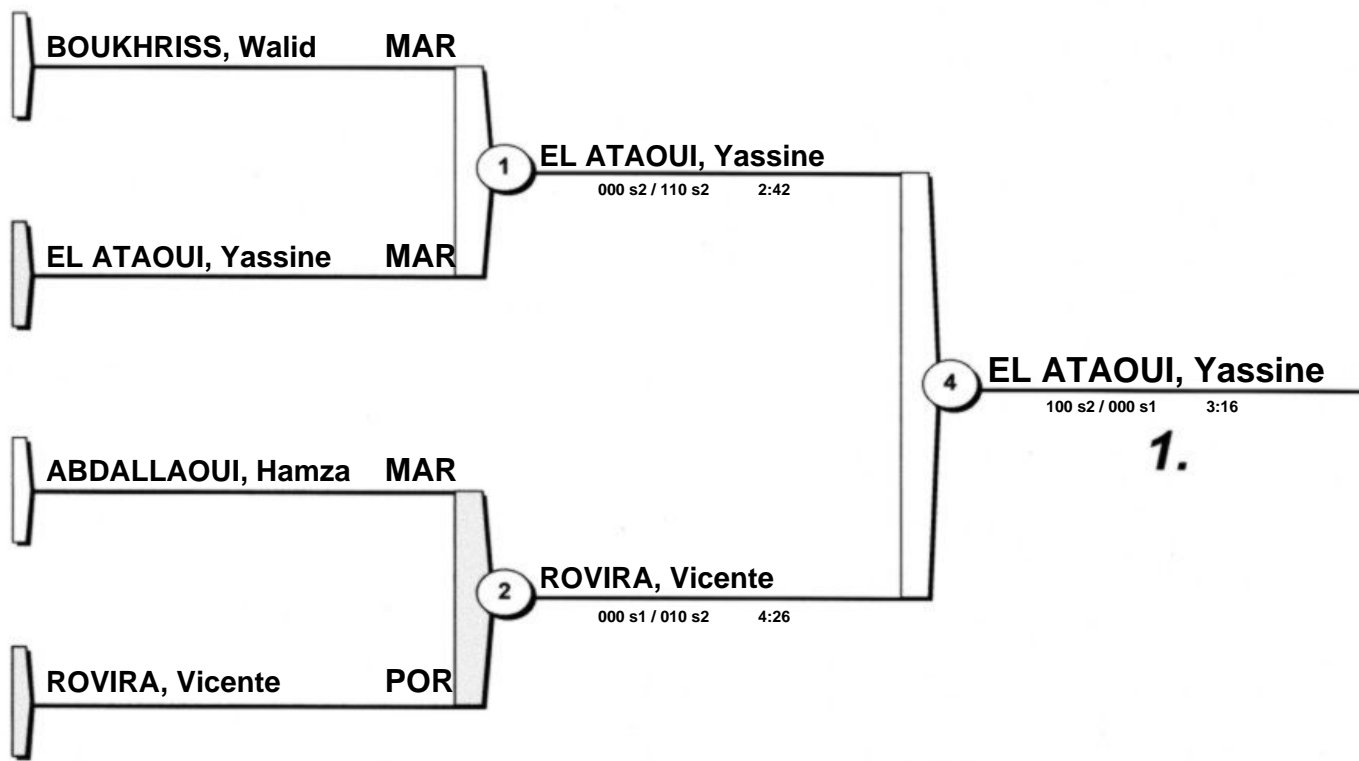

BOUKHRISS, Walid

ABDALLAOUI, Hamza

000 s3 / 100 s2 3:44

ABDALLAOUI, Hamza

1. EL ATAOU, Yassine MAR
2. ROVIRA, Vicente POR
3. ABDALLAOUI, Hamza MAR



African Junior Cup Casablanca 2019

(MAR Casablanca, 15 September 2019)

-100 kg

2 Judoka

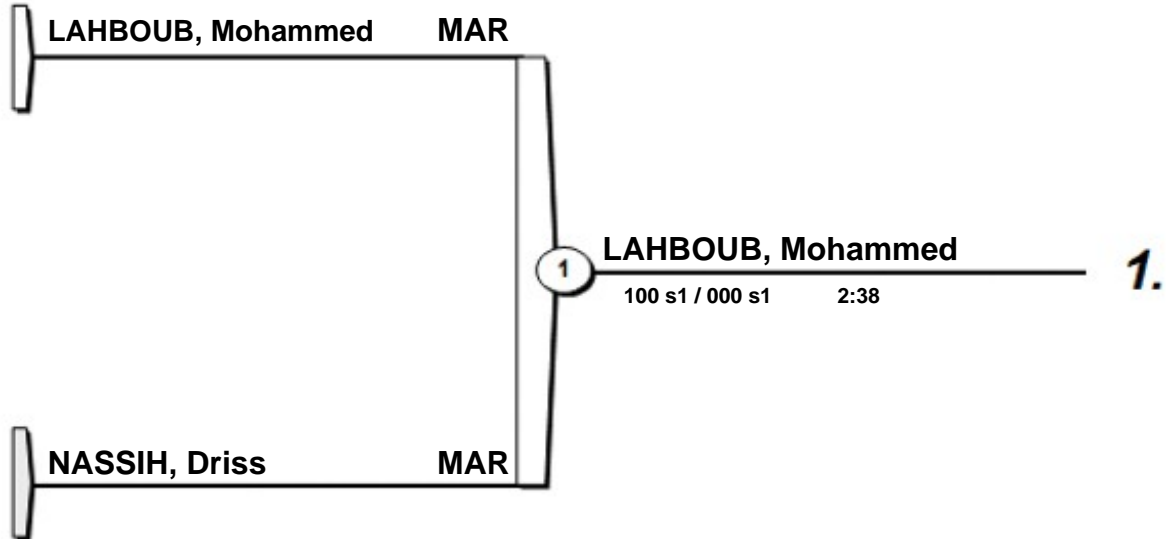

1. LAHBOUB, Mohammed MAR



African Junior Cup Casablanca 2019

(MAR Casablanca, 15 September 2019)

+100 kg

3 Judoka

			1	2	3		
1	ELHADAR, Elmehdi	MAR		-	-	0 (0)	
2	ESSERYRY, Zouhair	MAR	+		-	1 (10)	
3	HACHED, Anouar Abdelkader Hicham	ALG	+	+		2 (20)	

1	ELHADAR, Elmehdi	MAR	1	ESSERYRY, Zouhair	MAR
2	ESSERYRY, Zouhair	MAR		000 s3 / 100 s1	1:27

1	ELHADAR, Elmehdi	MAR	2	HACHED, Anouar Abdelkader Hicham	ALG
3	HACHED, Anouar Abdelkader Hicham	ALG		000 s3 / 100 s1	1:12

2	ESSERYRY, Zouhair	MAR	3	HACHED, Anouar Abdelkader Hicham	ALG
3	HACHED, Anouar Abdelkader Hicham	ALG		000 s2 / 100 s2	3:00

1. HACHED, Anouar Abdelkader Hicham **ALG**
2. ESSERYRY, Zouhair **MAR**



African Junior Cup Casablanca 2019

(MAR Casablanca, 15 September 2019)

-48 kg

5 Judoka

			1	3	5	Wins	Scores
1	HARBAOUI, Rania	TUN		+	+	2	(20)
3	BEN YOUNES, Imen	TUN	-		-	0	(0)
5	ELKHALIFI, Najlae	MAR	-	+		1	(7)

			2	4	Wins	Scores
2	MBOUP, Mbene	SEN		+	1	(7)
4	ELALAMI ELIDRISSI, Maroua	MAR	-		0	(0)

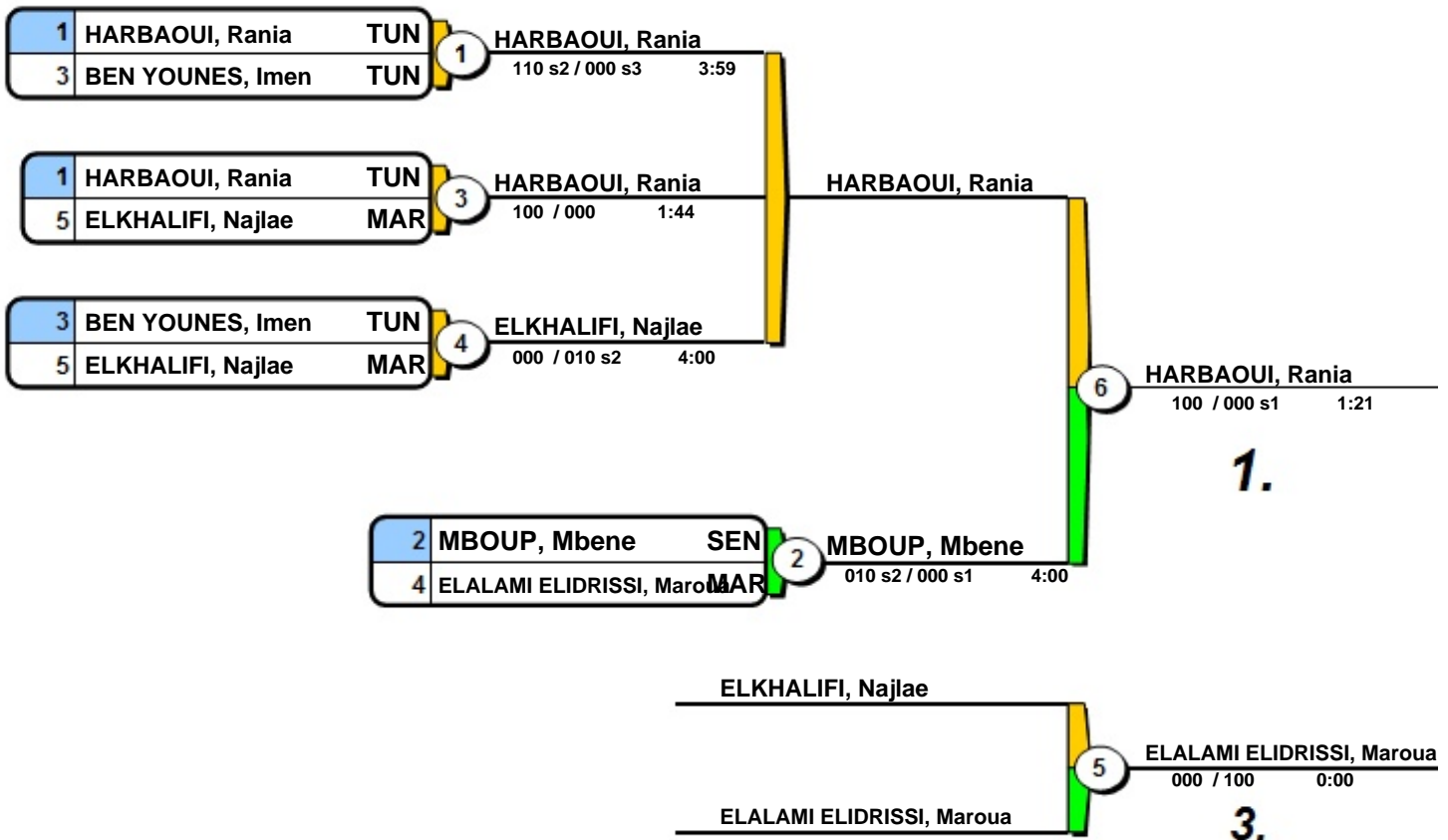

- 1. HARBAOUI, Rania TUN
- 2. MBOUP, Mbene SEN
- 3. ELALAMI ELIDRISSI, Maroua MAR



African Junior Cup Casablanca 2019

(MAR Casablanca, 15 September 2019)

-52 kg

4 Judoka

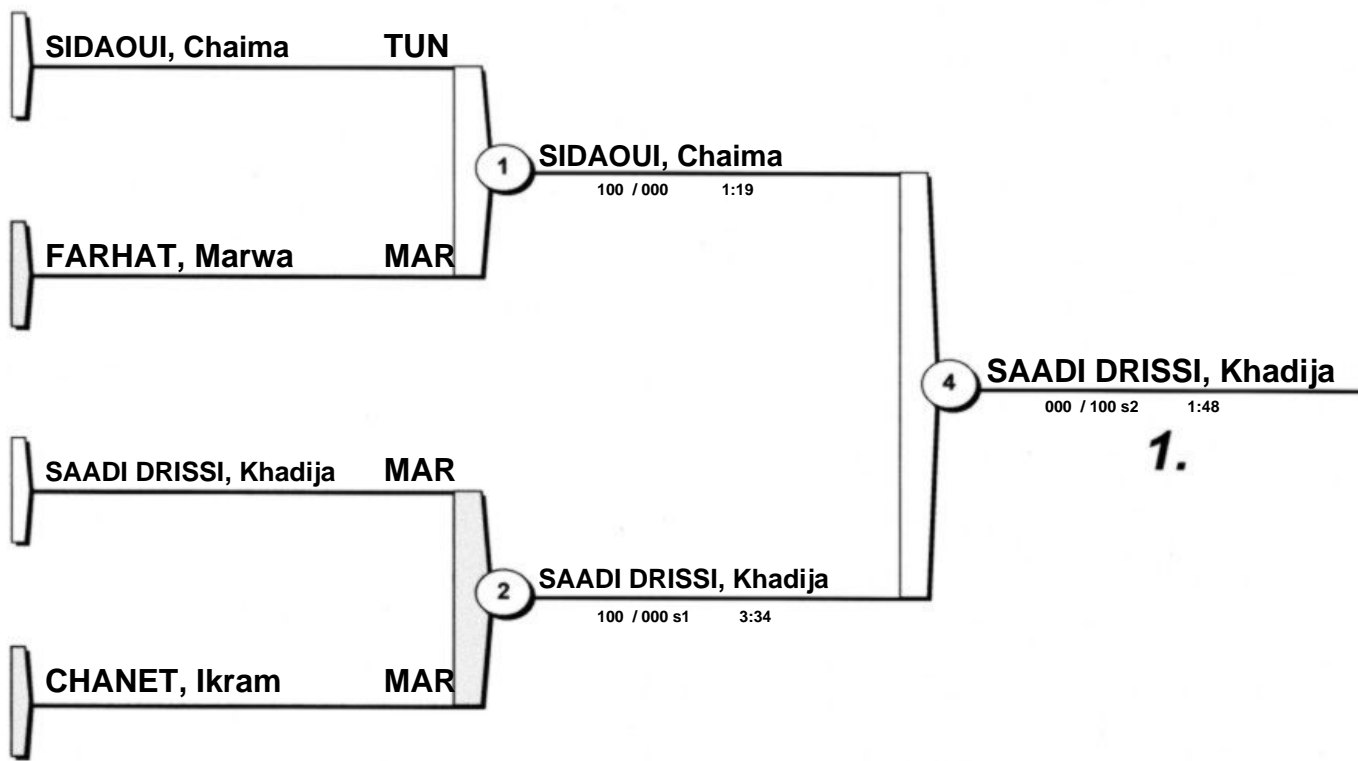

FARHAT, Marwa

CHANET, Ikram

000 s3 / 100 s2 2:10

CHANET, Ikram

- | | | |
|----|-----------------------|-----|
| 1. | SAADI DRISSI, Khadija | MAR |
| 2. | SIDAOU, Chaima | TUN |
| 3. | CHANET, Ikram | MAR |



African Junior Cup Casablanca 2019

(MAR Casablanca, 15 September 2019)

-57 kg

6 Judoka

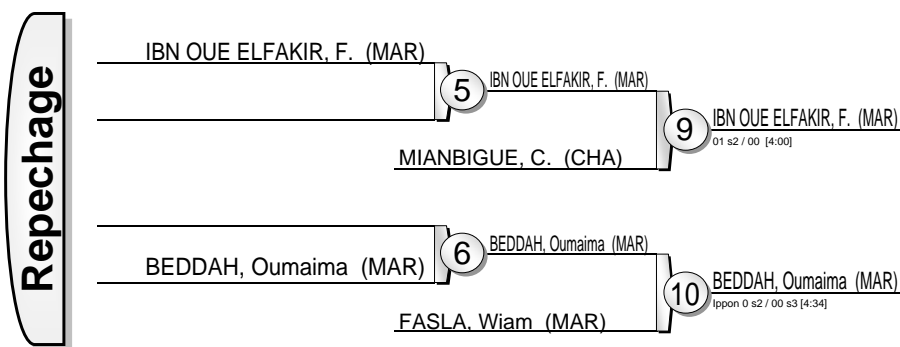
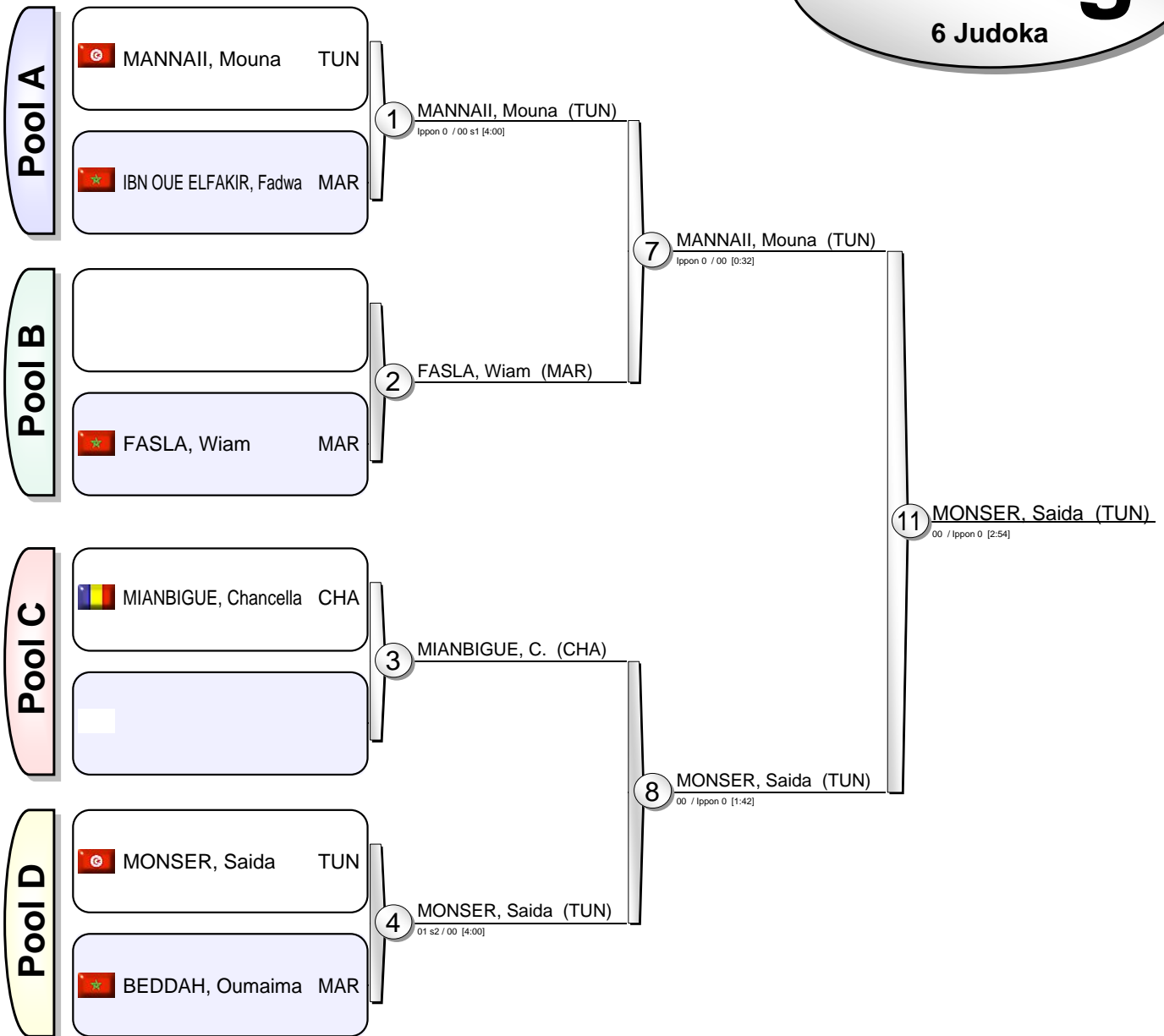

Results		
1.	MONSER, Saida	TUN
2.	MANNAIL, Mouna	TUN
3.	IBN OUE ELFAKIR, Fadwa	MAR
3.	BEDDAH, Oumaima	MAR
5.	MIANBIGUE, Chancella	CHA
5.	FASLA, Wiam	MAR
7.		
7.		



African Junior Cup Casablanca 2019

(MAR Casablanca, 15 September 2019)

-63 kg

6 Judoka

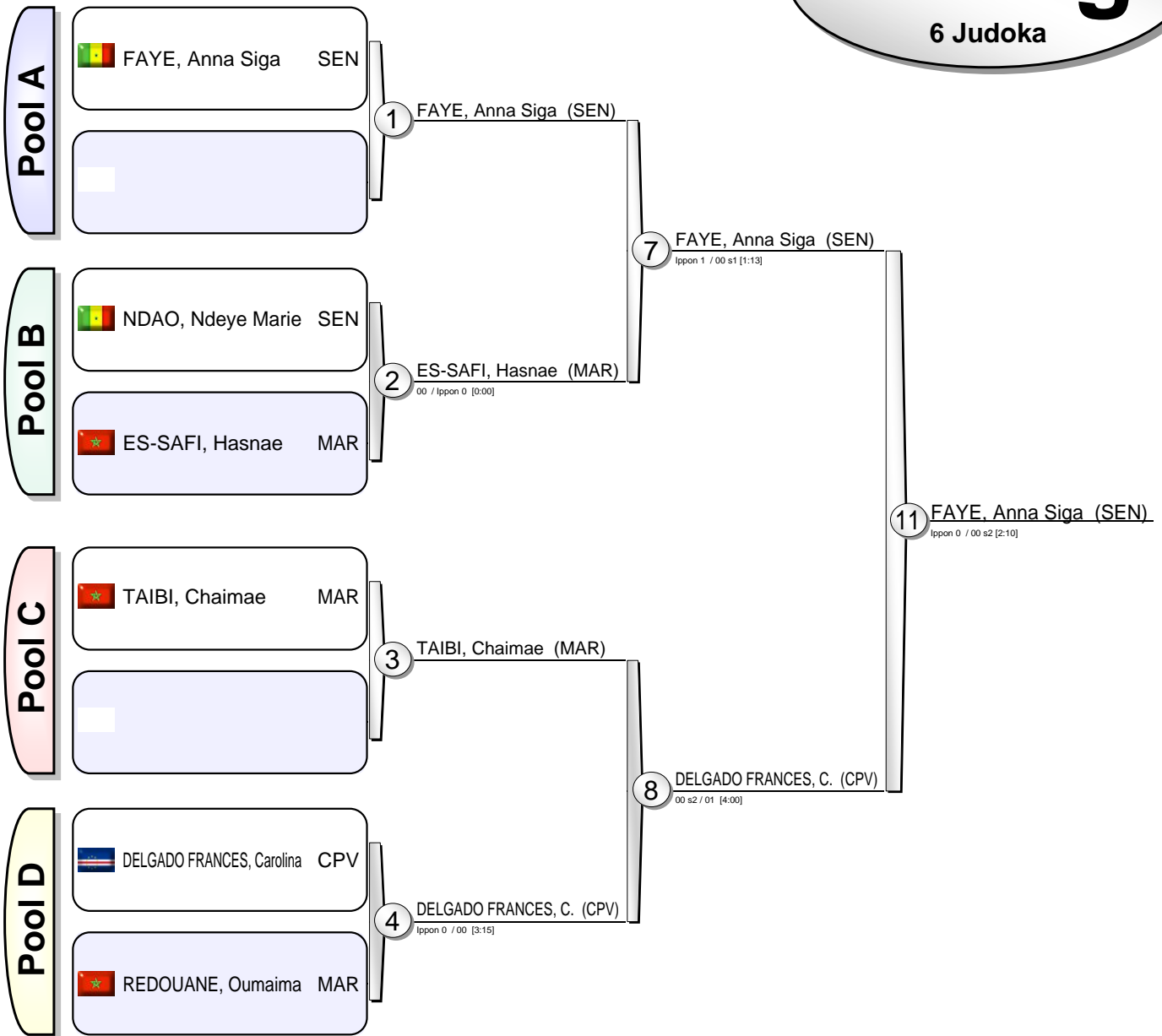

Results

- FAYE, Anna Siga (SEN)
- DELGADO FRANCES, Carolina (CPV)
- TAIBI, Chaimae (MAR)
- REDOUANE, Oumaima (MAR)
- NDAO, Ndeye Marie (SEN)
- ES-SAFI, Hasnae (MAR)
-
-



African Junior Cup Casablanca 2019

(MAR Casablanca, 15 September 2019)

-70 kg

5 Judoka

	1	3	5	Wins	Scores
1 ZIANE, Khaoula MAR		+	-	1	(10)
3 OUARANI, Khadija MAR	-		-	0	(0)
5 DIATTA, Yacine SEN	+	+		2	(20)

	2	4	Wins	Scores
2 KHAIRI, Oulaya MAR		+	1	(10)
4 ESSATOURI, Nassma MAR	-		0	(0)

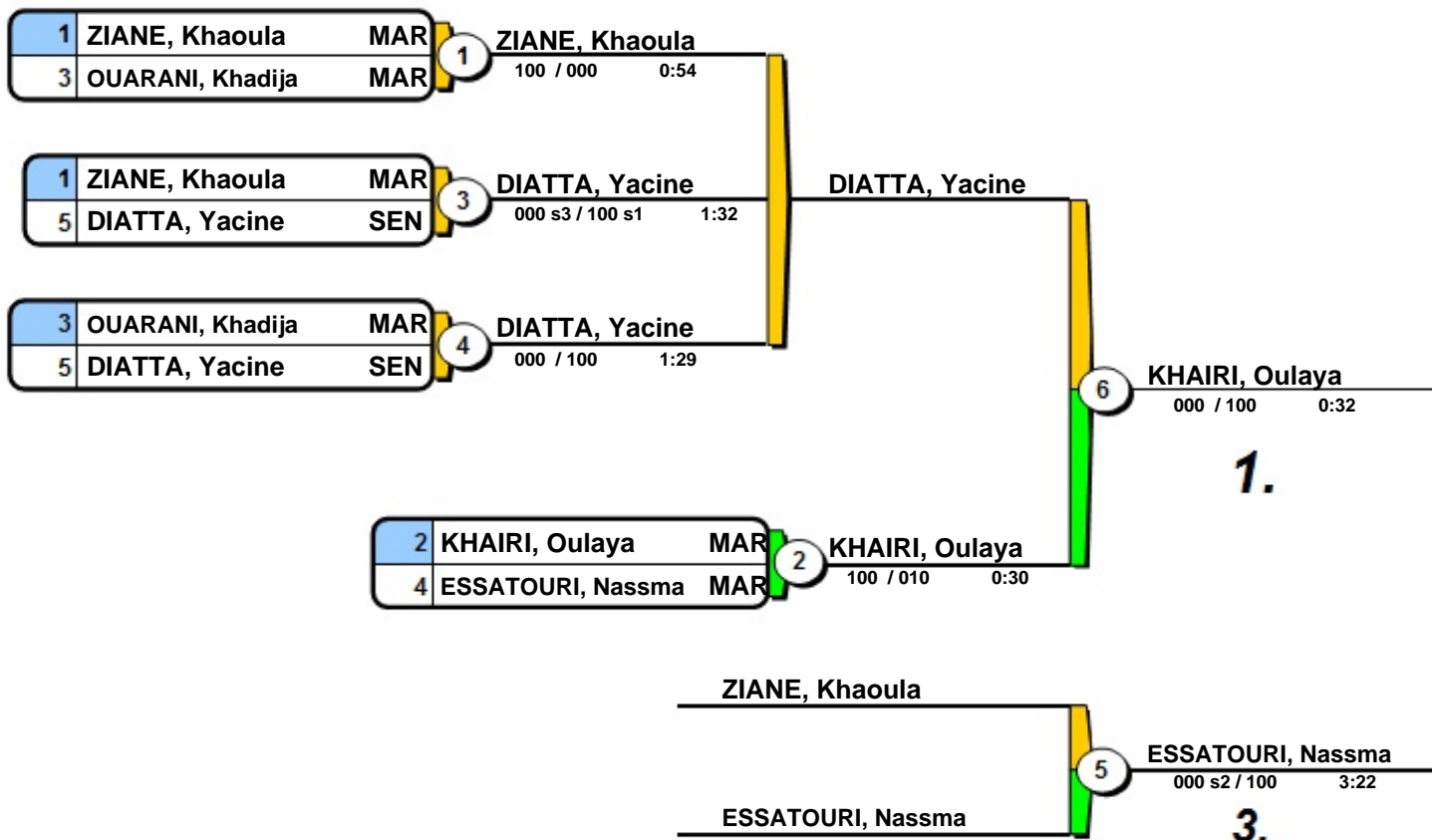

- 1. KHAIRI, Oulaya MAR
- 2. DIATTA, Yacine SEN
- 3. ESSATOURI, Nassma MAR



African Junior Cup Casablanca 2019

(MAR Casablanca, 15 September 2019)

-78 kg

2 Judoka

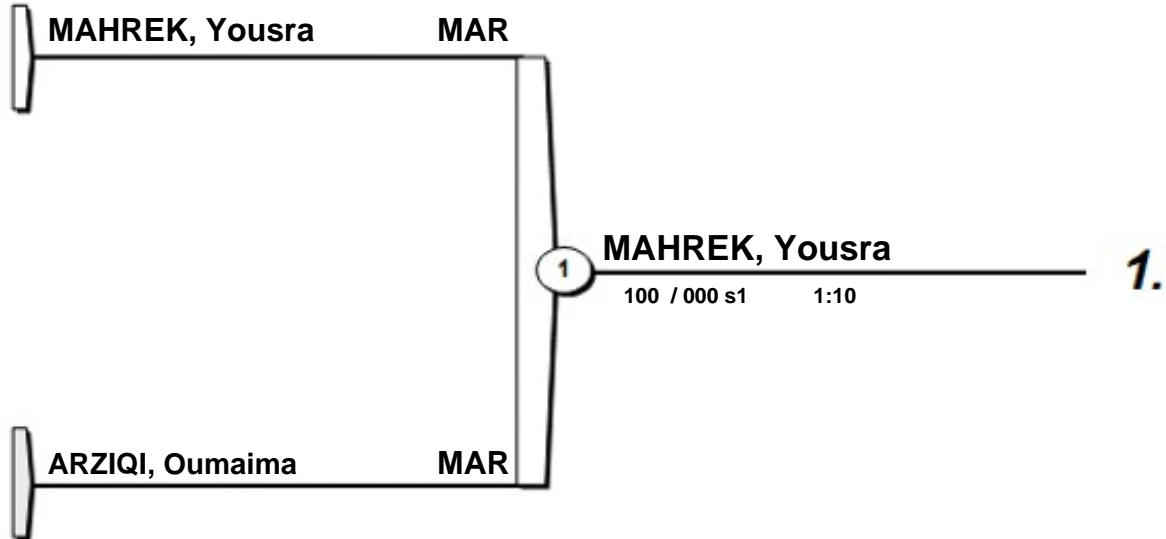

1. MAHREK, Yousra MAR



African Junior Cup Casablanca 2019

(MAR Casablanca, 15 September 2019)

+78 kg

2 Judoka

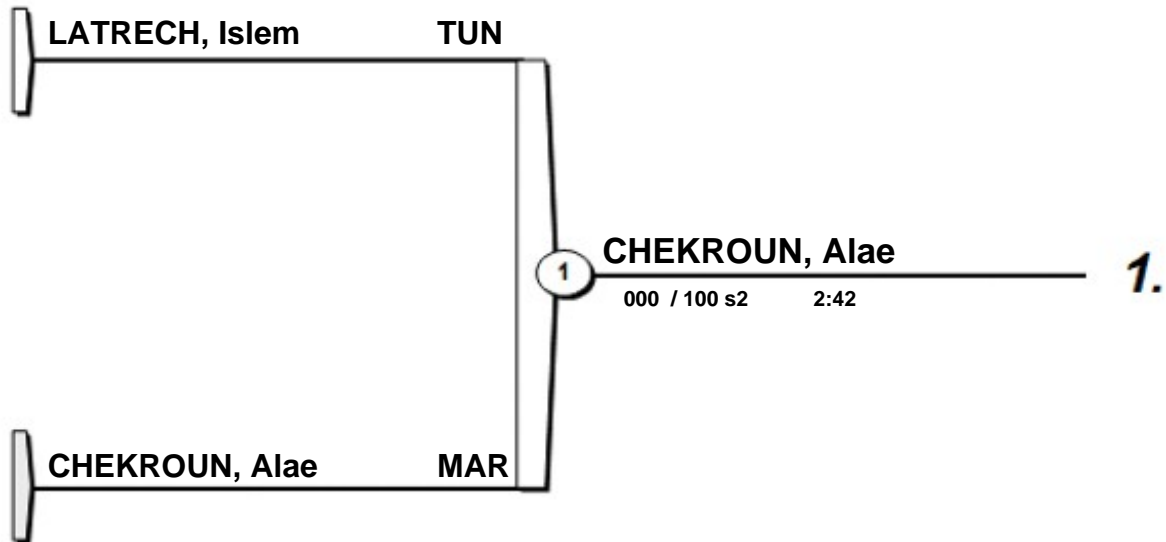

1. CHEKROUN, Alae MAR